

Power Contactor
RLY-48150

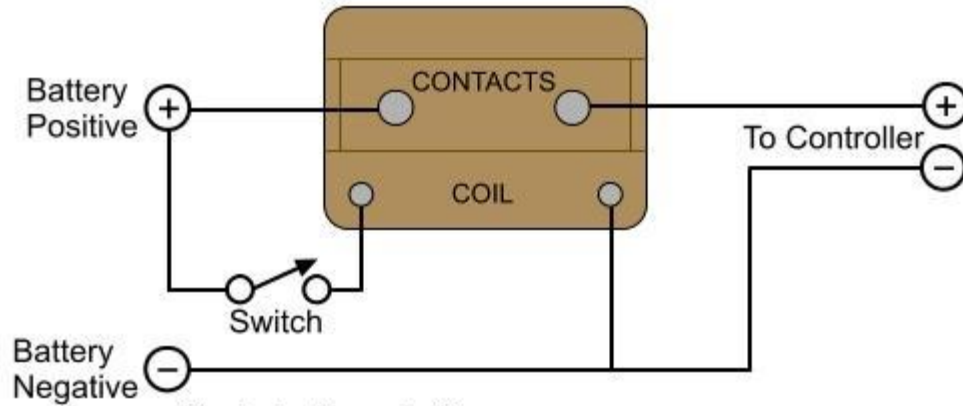

Contacts: Normally Open
Maximum Continuous Contacts Load: 150 Amps
Rated Coil Voltage: 48 Volts DC
Maximum Coil Voltage: 60 Volts DC
Coil Pull-In Voltage: 31 Volts DC
Coil Pull-Out Voltage 12 Volts DC