

Power Contactor
RLY-36150

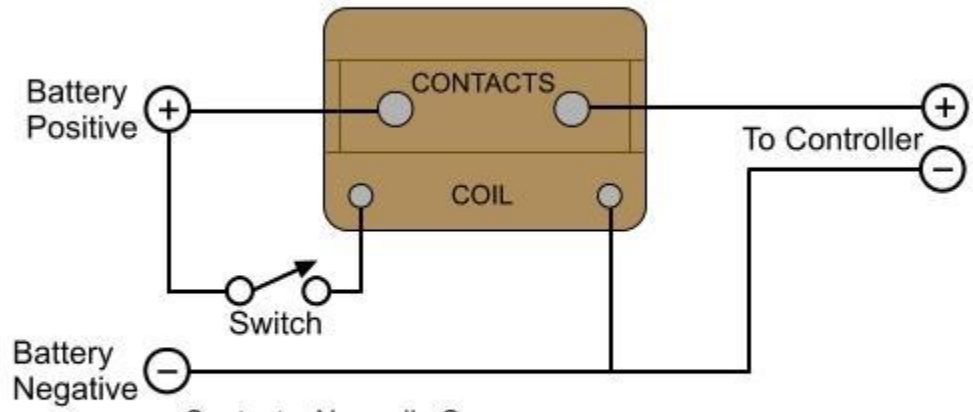

Contacts: Normally Open
Maximum Continuous Contacts Load: 150 Amps
Rated Coil Voltage: 36 Volts DC
Maximum Coil Voltage: 48 Volts DC
Coil Pull-In Voltage: 22 Volts DC
Coil Pull-Out Voltage 12 Volts DC