

THR-181R Wiring Directions

Wire Color	Function
Red	+5 Volts Input for Throttle
Black	-Negative (Shared for Throttle and Meter)
Green	Throttle Signal (+1-4 Volts Output)
Yellow	Key Switch Contact Power Input
Blue	Key Switch Contact Power Output

Key switch contacts are open when key switch is in the off position and closed when key switch is in the on position.

Power switch input wire provides battery Voltage to the Voltmeter.

The Voltmeter is off when key switch is in the off position and on when key switch is in the on position.

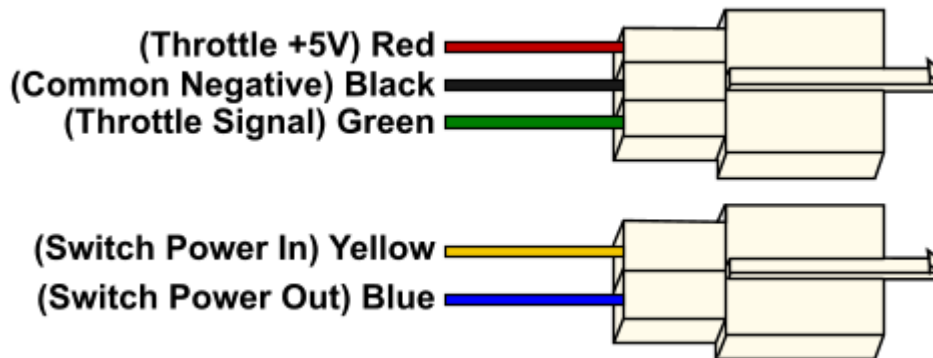

⚠ Important Must Read Information

The positions of the wires in the 3-wire throttle connector may not be correct for the controller that the throttle is used with and miswiring a throttle can damage it. The throttle's +5V red wire must go to the controller's +5V red wire, and the throttle's negative black wire must go to the controller's negative black wire, and after that the two remaining throttle signal wire colors can go together.