

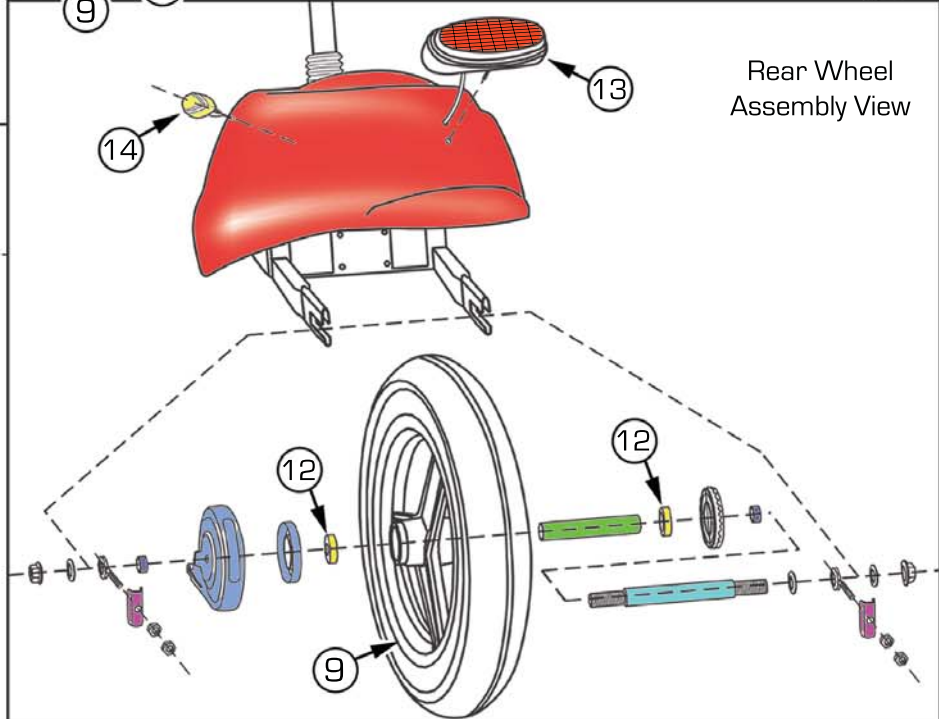

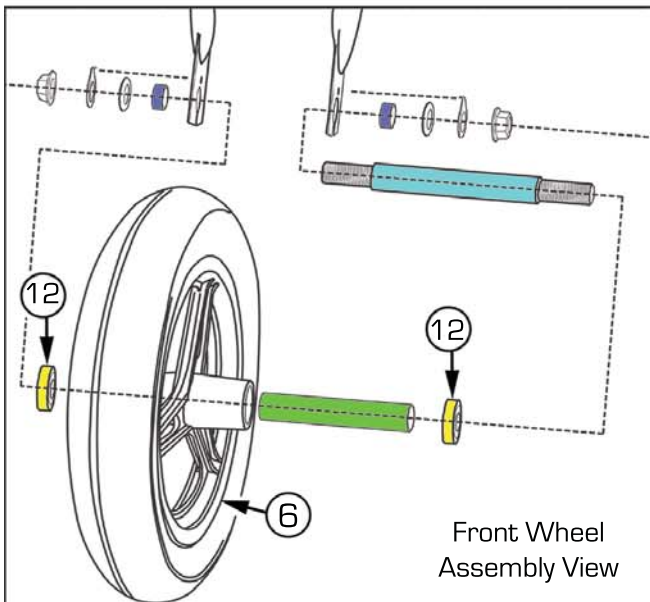

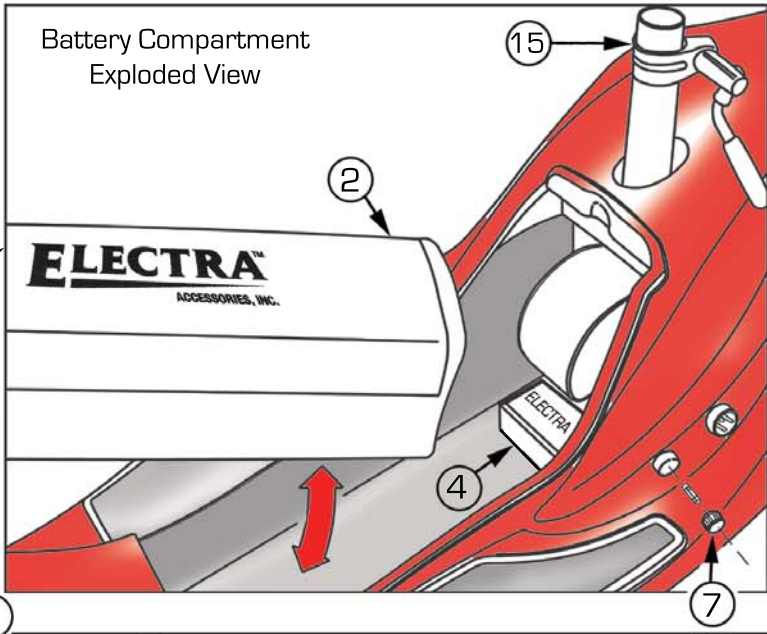

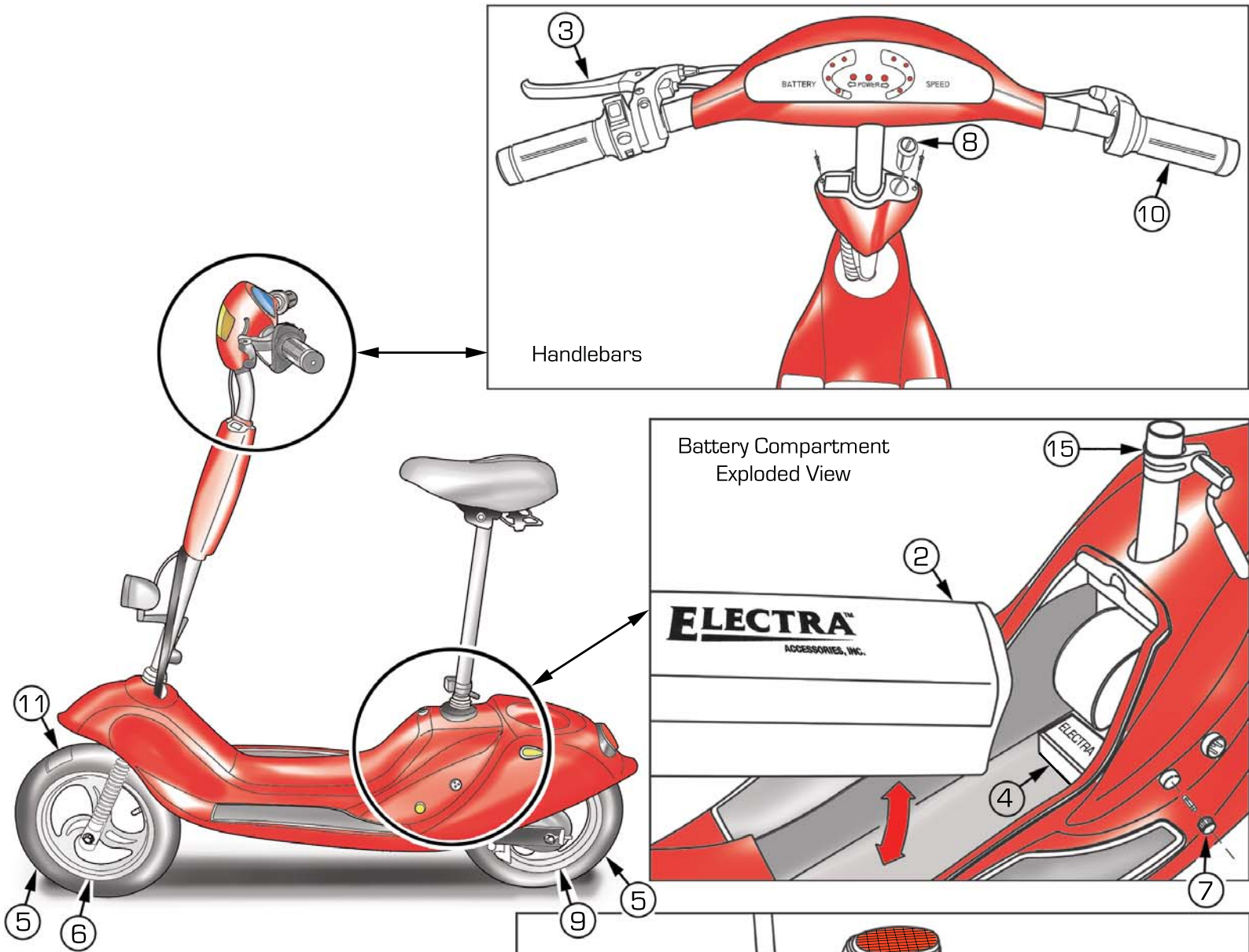

MODEL 88701 & 88705 - SCOOT-N-GO

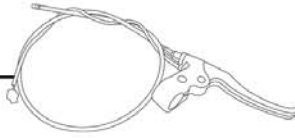
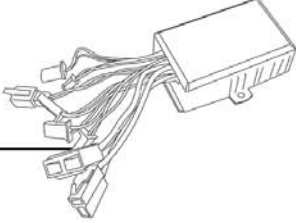
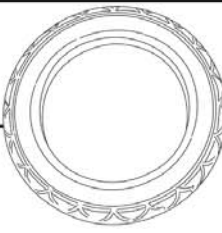
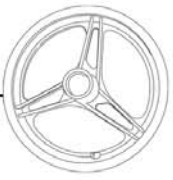
See Reverse for Order Instructions

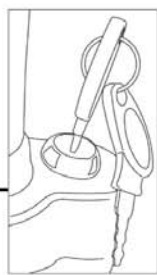
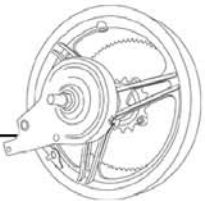
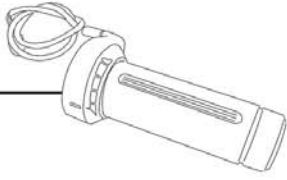
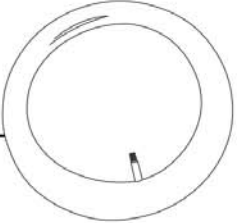
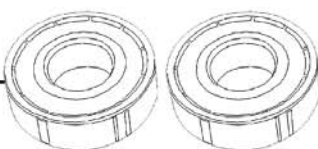

①	Name	Part Number	
②	24 Volt Battery Pack	88610	
③	24 Volt Battery Pack	88614	
④	Brake Lever (Rear)	88616	
⑤	Control Panel	88618	
⑥	12" Tire	88652	
⑦	Mag Front Wheel	88624	
⑧	Fuse Cap	33396	
⑨	Key Ignition Cylinder with Key	88636	
⑩	Mag Rear Wheel with Brake	88645	
⑪	Throttle with Cable	88653	
⑫	12" Tire Tube	88654	
⑬	Wheel Bearings	33421	
⑭	Brake Light	88657	
⑮	Turn Signal Lights (2)	88658	
⑮	Tightening Clamp	88651	