

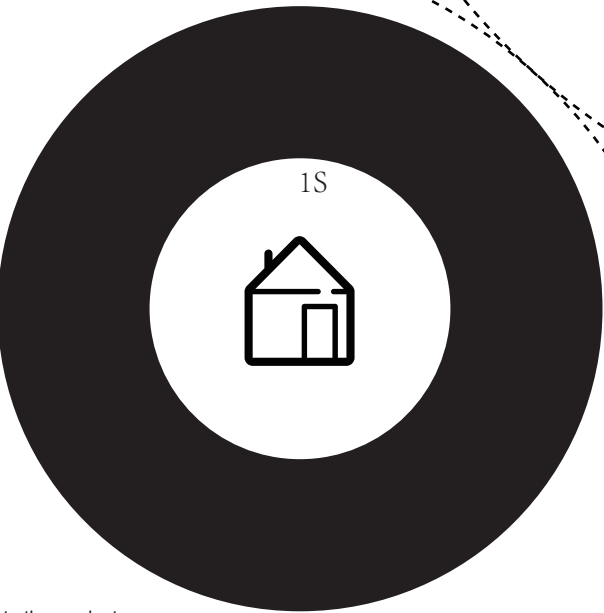

1S
ELECTRIC SCOOTER

iScooter

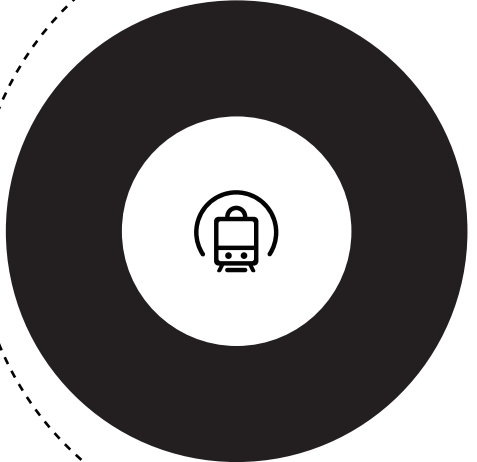

USER MANUAL



The manufacturer reserves the right to make changes to the product, and update this manual at any time.



Contents

1. Package Contents	01
2. Product Overview	02
3. Assembly	04
4. Charging	05
5. First Riding	05
6. Riding Basics	06
7. Safety Instructions.....	07
8. Dangerous Actions (No Attempting!)	08
9. Riding Notice	09
10. Folding and Carrying	10
11. Disc Brake Adjustment	11
12. Daily Care and Maintenance	12
13. Specifications	13
14. Limited Warranty Statement	14
15. Question & Answer	15
16. Contact Us	15

Package Contents



When unboxing your 1S electric scooter, please verify that the below items are included in the package. If anything is missing or damaged, please contact iScooter customer service for support: vip.support@iscooterglobal.com



Charger



4 x Screws

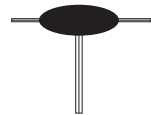

Allen Wrench

Product Overview

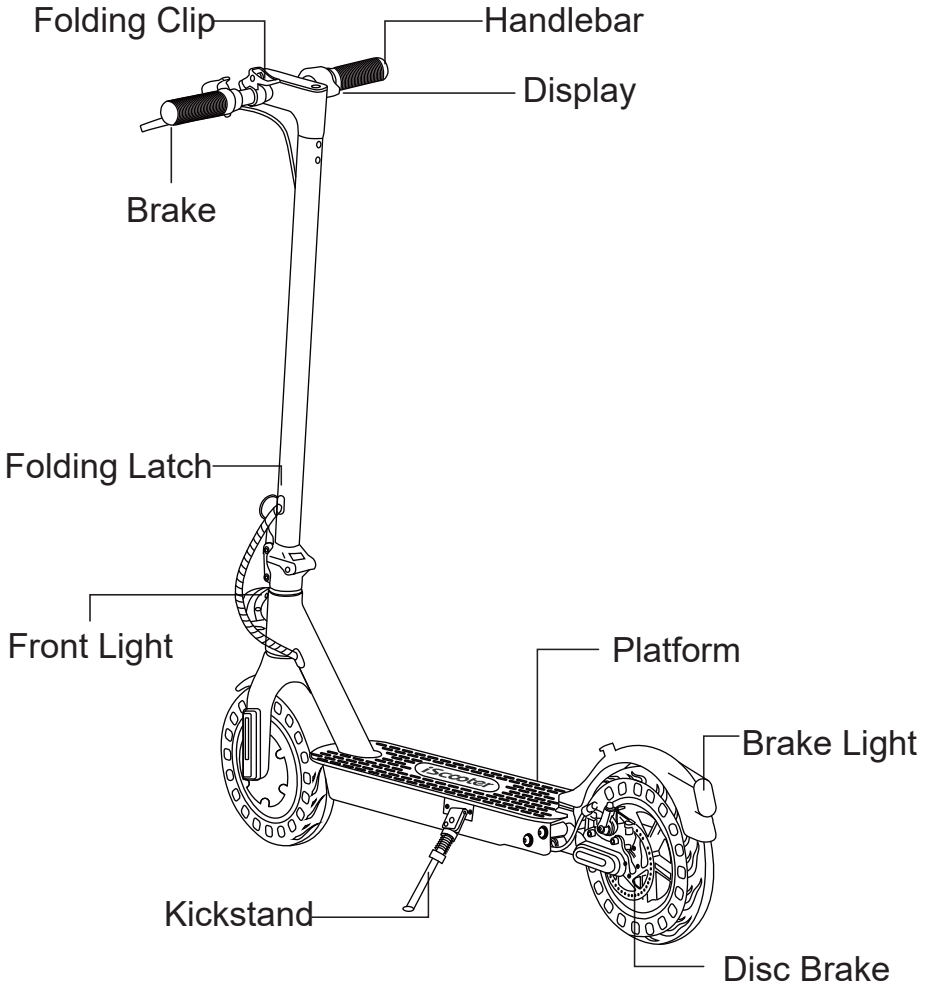

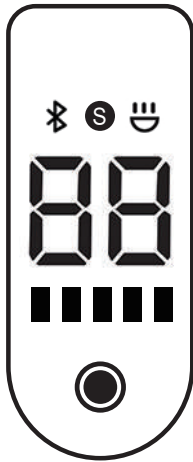

Tips

When the scooter starts to coast, put both feet on the deck and press the accelerator (the accelerator initiates once the coasting speed exceeds 3 mph). Or you can connect the "MiniRobot" APP, then, turn on the zero start.

Control Panel



Power Button

Click to turn on. Long press to turn off.



Battery Indicator

The power level is indicated by five battery bar on the control panel.



Light

Turn on your scooter, one-click to turn on/off the front light.



Mode

Double-click to switch power mode.



Cruise Control

Keep same speed for 3 seconds, and it will beep and active the cruise control.



Lock indicator

The scooter can be locked and unlocked by MiniRobot app.

Assembly

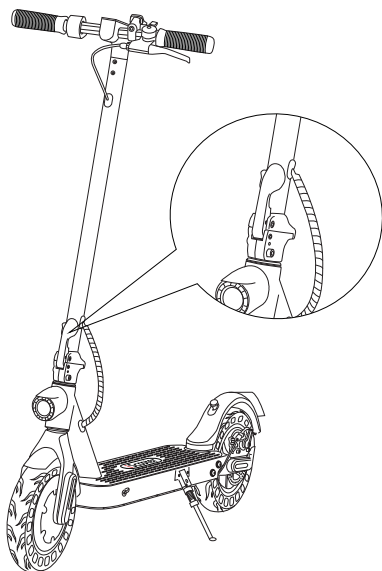

1. Unfold the stem and close the folding latch until you hear a click. Then unfold the kickstand to support the scooter.

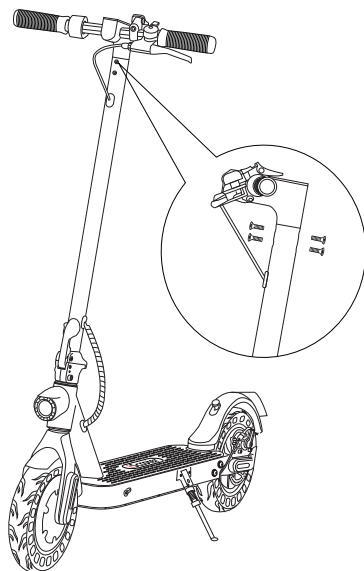

2. Install the 4PCS screws (two on each side) into the holes, then tighten the each screws properly with the included hex wrench.

Attention

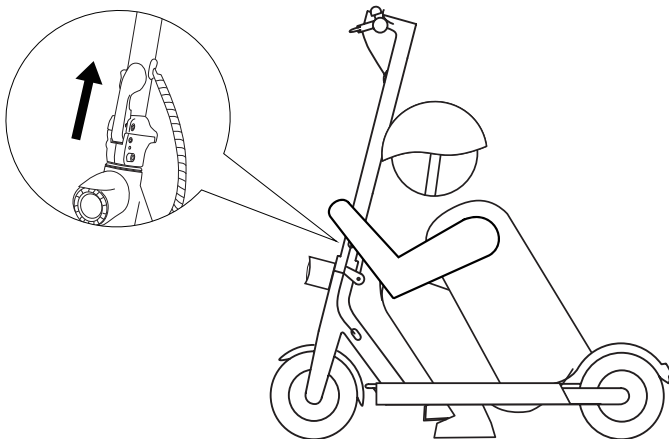

Folding latch:

Fold up the latch until you hear a click. You must make sure the folding latch is locked before riding.

Charging

- Your scooter will be fully charged when the LED light on the charger changes to green from red.
- The scooter has charging protection and charging will cut off automatically after fully charge.
- Even so, we still don't recommend charging your scooter for a long time more than 24 hours at one time.
- Do not connect the charger if the charging port is wet.
- Keep the charging port closed when not charging.

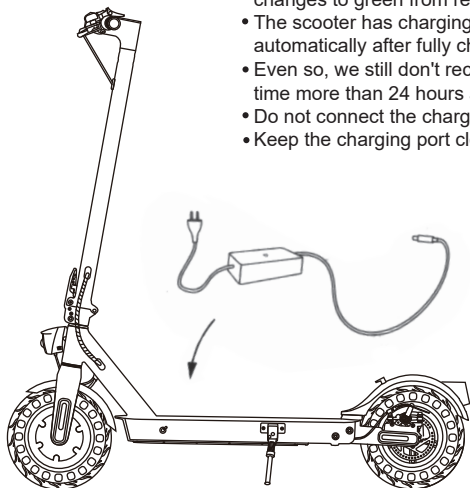

First Riding



App Store

Download the "MiniRobot" app from the App Store(iPhone) or Google Play (Android phone) for more information and functions.

When the scooter starts to coast, put both feet on the deck and press the accelerator (the accelerator initiates once the coasting speed exceeds 3 mph). Or you can connect the "MiniRobot" APP, then, turn on the zero start.

Riding Basics

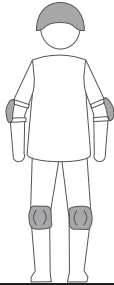

⚠ Wear helmets and knee pads in case of falls and injuries when you learn to ride the scooter, as shown in the figure.

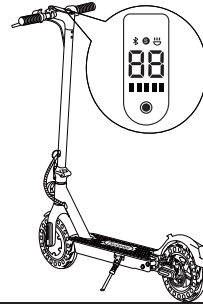

1. Turn the power on, and check the electricity indicator.



2. Stand on the base with one foot and propel yourself with the other foot.

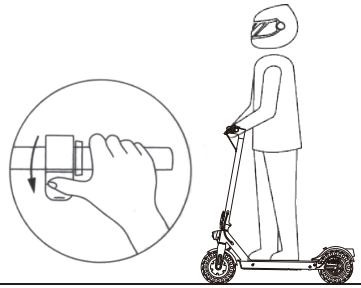

3. When the scooter starts to coast, put both feet on the deck and press the accelerator (the accelerator initiates once the coasting speed exceeds 3mph)

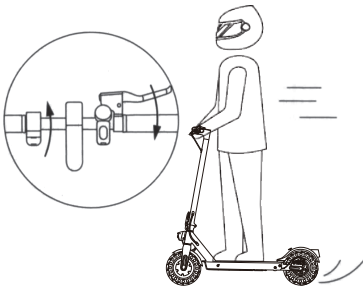

4. Release the accelerator and the kinetic energy recovery system (KERS) initiates automatically to brake slowly; And squeeze the brake lever for a sudden brake.

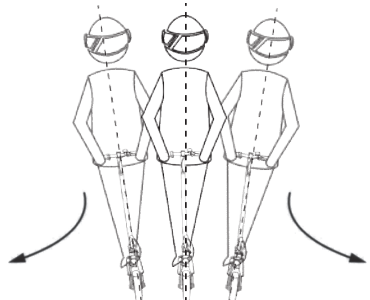

5. Tilt your body to the steering direction as you turn, and slowly turn the handlebar.

Safety Instructions



Do not ride in the rain.



Please keep a medium or low speed (5mph) when you ride through speed bumps, elevator door sills, bumpy roads or other uneven surfaces. Slightly bend your knee to better adjust mentioned surfaces.

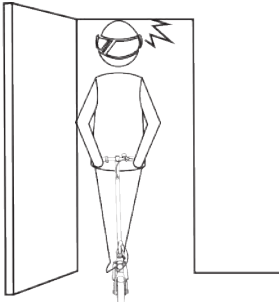

Look out for doors, elevators and other overhead obstacles.

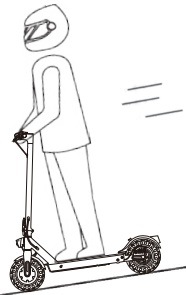

Do not accelerate when you go downhill.



Do not press the accelerator when you're walking alongside the scooter.



Always steer clear of obstacles.



Do not hang bags or other heavy stuff on the handlebar.



Keep both feet on the deck all time.

Dangerous Actions (No Attempting!)

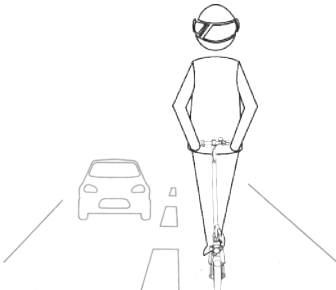

Do not ride in traffic lanes or residential areas where vehicles and pedestrians are both allowed.

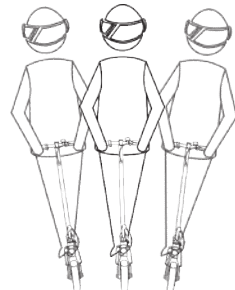

Do not turn the handlebar violently during high-speed riding



Do not ride in a ponding that is higher than 2cm.

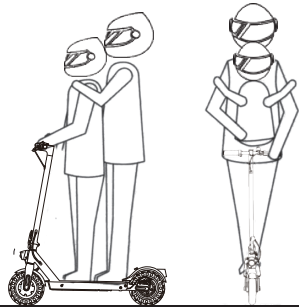

Do not ride with anyone else, including children.

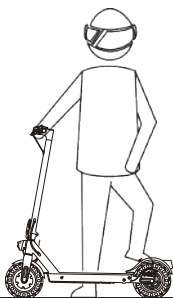

Keep your feet off the rear mudguard.

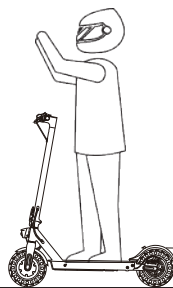

Always keep your hands on the handlebar.

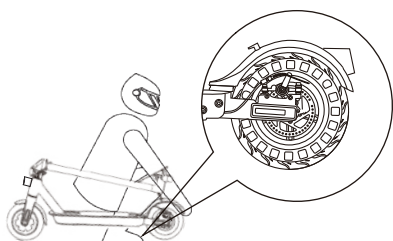

Do not touch the disc brake.

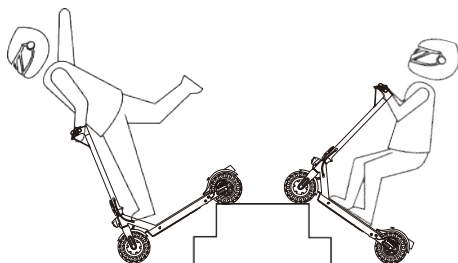

Do not try riding up or down stairs, and jumping over obstacles

Riding Notice

The iScooter 1S electric scooter is a leisure device. But once they're in a public area, they'll be seen as vehicles, subjecting them to any risks faced by vehicles. For your safety, please follow instructions in the manual and traffic laws and regulations set forth by government and regulatory agencies.

- At the same time, you should understand that risks cannot be entirely avoided as others may violate traffic regulations and drive incautiously, and you're exposed to road accidents just as when you're walking or biking. The faster the scooter is, the longer it takes to stop. On a smooth surface, the scooter may slip, lose balance, and even result in a fall. Thus it is crucial that you use caution, keep proper speed and distance, especially so when you're unfamiliar with the place.
- Respect pedestrians' Right of Way. Try not to startle them while driving, especially children. When you ride from behind pedestrians, ring your bell to give them a heads-up and slow your scooter to pass from their left (applicable to countries where vehicles drive on the right). When you ride across pedestrians, keep to the right at a low speed. When you drive across pedestrians, keep the lowest speed or getting off the vehicle.

- Closely follow the safety instructions in the manual. iScooter shall not be liable for any financial losses, physical injuries, accidents, legal disputes and other interest conflicts resulted from actions that violate user instructions.
- Do not lend your scooter to whoever doesn't know the operations. And when you do lend it to your friends, please take the responsibility to ensure he/she knows the operation and wears the safety gear.
- Check the scooter before every use. When you note loosen parts, low battery alerts, excessive wear, strange sounds, malfunctions and other abnormal conditions, stop riding.
- **WARNING – Risk of Fire – No User Serviceable Parts.**

Folding and Carrying

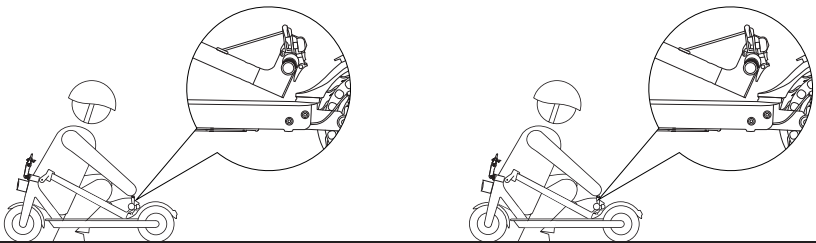
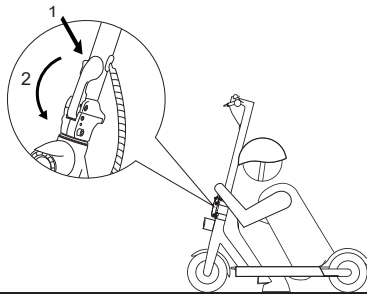

Make sure that the scooter's turned off. To fold, unlock the folding mechanism, and bend the handlebar stem to hook the buckle on the rear fender. To open, press the bell trigger to remove from the buckle, erect the handlebar and lock the folding structure.

Disc Brake Adjustment

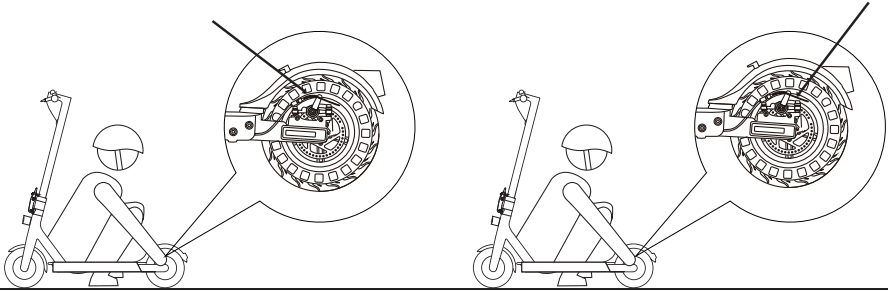

To adjust the disc brake sensitivity:

You need the Allen wrench to loosen the screw on the rocker.

- When the disc brake is too sensitive, rotate the disc brake rocker down a bit. Then, reinstall the screw back to the brake cable core to tighten.
- When the disc brake cannot stop, rotate the disc brake rocker up a bit. Then, reinstall the screw back to the brake cable core to tighten.

Notice: The disc brake may squeak when in use until it is broken in. This is normal and does not affect the brake's function or performance.

To remove the disc brake noise,

First make sure the scooter is turned off. For easier operating, we suggest you put the scooter on the desk.

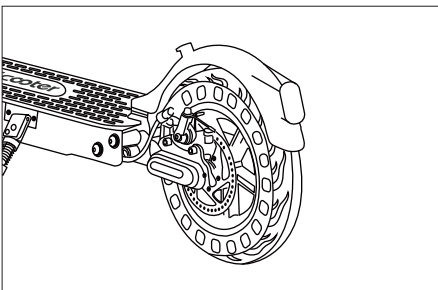

- Loosen two screws on the pump (not the screw on the rocker).
- Adjust the position of the disc brake pump to ensure that the brake disc is in the middle of the two brake pads.
- Keep the brake disc and brake pad not touching each other.
- Hold the disk brake pump in the desired position, then retighten the screws to the pump.

Daily Care and Maintenance

Cleaning and storage

If you see stains on the scooter's body, wipe them off with a damp cloth. If the stains won't scrub off, put on some toothpaste, and brush them with a toothbrush, then wipe them off with a damp cloth.

Notes:

- Do not clean the scooter with alcohol, gasoline, kerosene or other corrosive and volatile chemical solvents to prevent fire damage.
- Do not wash the board with a high-pressure water spray. During cleaning, make sure that the scooter's turned off, the charging cable is unplugged, and the rubber flap is closed as water leakage may result in electric shock or other major problems. When the scooter not in use, keep it indoors where it is dry and cool.
- Do not put it outdoors for a long time. Excessive sunlight, overheating and overcooling accelerate the battery pack's lifespan.

Battery maintenance

1. Use original battery packs, use of other models or brands may bring about safety issues;
2. Do not touch the contacts. Do not dismantle or puncture the casing. Keep the contacts away from metal objects to prevent short circuit which may result in battery damage or even injuries and deaths;
3. Use original power adapter to avoid potential damage or fire;
4. Mishandling of used batteries may do tremendous harm to the environment. To protect natural environment, please follow local regulations to properly dispose used batteries.
5. After every use, fully charge the battery to prolong its lifespan.

Storage and Disposal

1. Please try to store the scooter in a cool and dry place between 14°F and 104°F. In extremely humid environments the interior of the scooter may suffer condensation or even water accumulation, which may damage the battery rapidly. Devices are not intended for use at elevations greater than 2000 m above sea level. Prolonged Exposure to UV Rays, Rain and the Elements May Damage the Enclosure Materials, Store Indoors When Not in Use.
2. In daily use, try to avoid recharging the scooter after completely exhausting the battery. If the battery is low, charge it as soon as possible.
3. Please charge the scooter every other month to preserve the battery.

Specifications

1S	Item	Electric Scooter
Dimensions	Unfolded (Length. x Width x Height)	45*17*45 inch/115*43*115 cm
	Folded (Length. x Width x Height)	45*17*19 inch/115*43*49 cm
weight	Net Weight	29.7 lbs/13.5 kg
User	Load	264 lbs/120 kg
	Recommended Age	14+
Scooter	Max.Speed	18.6 mph/30 km/h
	Max.Range	14-17.5 miles/22-28 km
	Max. Slope	15%
	Operating Temperature	32-104°F
	IP Rating	IP54
Battery	Voltage	36 V
	Max.Charging Voltage	42 V
	Capacity	7.5 AH
Motor	Nominal Power	350 W
Charger	Input Voltage	100-240 V
	Output Voltage	42 V
	Output Current	2A
	Charging Time	≈ 4-6 h

(1) The height of the body: Distance from the ground to the highest end of the body.

(2) Description of the battery life: It is measured under the condition of full charge, a load of 150 lb, at 77°F, on a flat road without wind, and at a speed of 9.3mph. The real battery life will differ with different factors of the load, humidity, wind speed and operation habits.

(3) The maximum allowable weight shall be kept within 264 lb (driver and objects included) in any case. Consider an extra weight of the clothes or other accessories with us during the trip and the gravity generated by speed, the scooter will not support it if this load limit is exceeded.

Limited Warranty Statement

30 DAY SATISFACTION GUARANTEED RETURN POLICY

If you are unsatisfied with your purchase, iScooter's return policy allows you to return the product purchased on the Authorization channel within 30 days counting from the date of receipt of shipment, and request a refund from the Authorization channel for any reason. Note: Express shipping cost is non-refundable.

For the return request, iScooter is not responsible for lost packages due to the carrier, or products received that cannot be verified. Received products that have damage determined to have been caused by the end-user may be subject to denial of the return request.

TO QUALIFY FOR A REFUND, ALL THE FOLLOWING CONDITIONS MUST BE MET

1. A Return Merchandise Authorization (RMA) must be requested from iScooter within 30 days from the date of receipt of shipment. To request an RMA, contact iScooter Service Team at vip.support@iscooterglobal.com.
2. The cost of return shipping will be borne by the customer.
3. For warranty service, please keep your receipt and/or invoice to validate proof of purchase.
4. Returned product must be in good physical condition (not physically broken or damaged).
5. All accessories originally included with your purchase must be included with your return.
6. If you return a product to iScooter, (a) without an RMA from iScooter(b) without all parts included in the original package, iScooter retains the right to refuse delivery of such return.

LIMITED PRODUCT WARRANTY

iScooter warrants the original purchaser that your iScooter product shall be free from defects in materials and workmanship under normal use for a period aforementioned.

iScooter does not warrant the operation of the product will be uninterrupted or error-free.

iScooter is not responsible for damage arising from failure to follow instructions relating to the product's usage.

REMEDIES

If a hardware defect is found and a valid claim is received by iScooter within the Warranty Period, iScooter will, at its option and to the extent permitted by law, either (1) repair the product at no charge, using new or refurbished replacement parts or, (2) replace the product with a new or refurbished product. In the event of a defect, to the extent permitted by law, these are your sole and exclusive remedies. Shipping and handling charges may apply except where prohibited by applicable law. This Limited Warranty is valid only in the jurisdictions where the products are sold by www.iscooter.com, and is valid to the extent permitted by the applicable laws of such jurisdictions.

Any replacement hardware product will be warranted for the remainder of the original warranty period or thirty (30) days, whichever is longer, or for any additional period of time that may be applicable in your jurisdiction.

HOW TO OBTAIN WARRANTY SERVICE

A Warranty Service Order must be requested from iScooter within Warranty Period from the date of receipt of shipment. To request a Warranty Service Order, contact iScooter Service Team vip.support@iscooterglobal.com.

To obtain warranty service, you must deliver the product, in either its original packaging or packaging providing an equal degree of protection, to the address specified by iScooter. In accordance with applicable law, iScooter may require the customer to furnish proof of purchase details and/or comply with registration requirements before receiving warranty service. period or thirty (30) days, whichever is longer, or for any additional period of time that may be applicable in your jurisdiction.

LIMITATION OF DAMAGES

Except to the extent prohibited by applicable law, iScooter shall not be liable for any incidental, indirect, special, or consequential damages, including but not limited to loss of, even when iScooter has been advised of the profits, revenue or data, resulting from any breach of express or implied warranty or condition, or under any other legal theory possibility of such damages.

Some jurisdictions do not allow the exclusion or limitation of special, indirect, incidental or consequential damages, so the above limitation or exclusion may not apply to you.

Question & Answer

1. What if the E-Scooter arrived missing accessory or broken part?

A: Please take a photo and send to iScooter Support Team by sending email: vip.support@iscooterglobal.com. And iScooter Support Team will reply you soon and send correct accessory or part replacement.

2. Is the tire replaceable and how to replace the tire?

Yes, the tire is replaceable. Please contact iScooter support team for more information or search the video "How to replace the solid tire" in YouTube instead.

3. What if the rear disc brake of the scooter doesn't work well?

A: You may please contact us for instructions of brake adjusting, or search "How to adjust rear brake of scooter" in YouTube for tutorial video as well.

4. What should I do when I hear an unusual noise coming from the rear wheel?

A: It usually means your disc brake tilt and cause friction noise. Please see Disc Brake Adjustment page. If you still have problem, please contact us for help.

5. Why the screen returns an error code?

A: If you see any error code below, Please contact iScooter Support Team to remove the error code.

E04	Short Circuit Failure
E10	Controller/Instrument Communication Failure
E11	Motor Phase A Current Sensor Failure
E12	Motor Phase B Current Sensor Failure

E13	Motor Phase C Current Sensor Failure
E14	Accelerator Failure
E15	Brake Failure
E16	Motor Hall Failure

Contact Us

Contact us if you experience issues relating to riding, maintenance and safety, or errors/faults with your iScooter 1S electric scooter.

E-mail Service: vip.support@iscooterglobal.com